

*CX-9*



mazda



*zoom-zoom*

**GET IT FOR YOUR FAMILY**

**DRIVE IT FOR YOURSELF**





**TAKE THE FAMILY SUV  
TO A WHOLE NEW LEVEL**



PERFORMANCE AND STYLE  
THAT'S ALL ABOUT YOU

## IMAGINATION DRIVES US

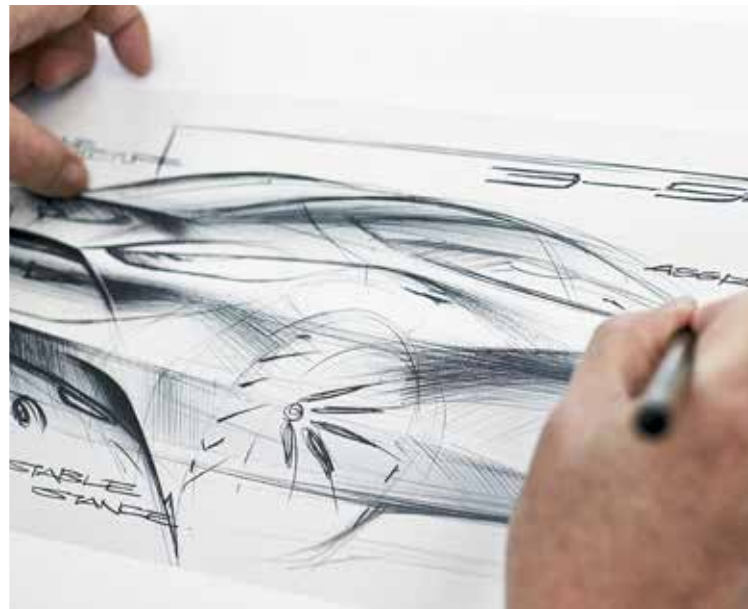

Imagination is the world's most valuable resource. It's our window to the future, because if we can imagine it, we can create it. Mazda is built on a foundation of imagination and ingenuity. It's the fuel behind all we create and achieve. It has given us SKYACTIV TECHNOLOGY, 'KODO – Soul of Motion' design and countless successes that once existed only in someone's imagination. These pages show how imagination is an integral part of our innovative cars.

## CONTENTS

04	INTRODUCTION
06	EXTERIOR
08	INTERIOR
10	PERFORMANCE
12	SKYACTIV
14	CONNECTIVITY
16	FEATURED INNOVATION
18	CAPACITY
22	SAFETY
24	i-ACTIVSENSE
26	MODELS
34	SPECIFICATIONS
40	CONFIDENCE
41	COLOUR & TRIM

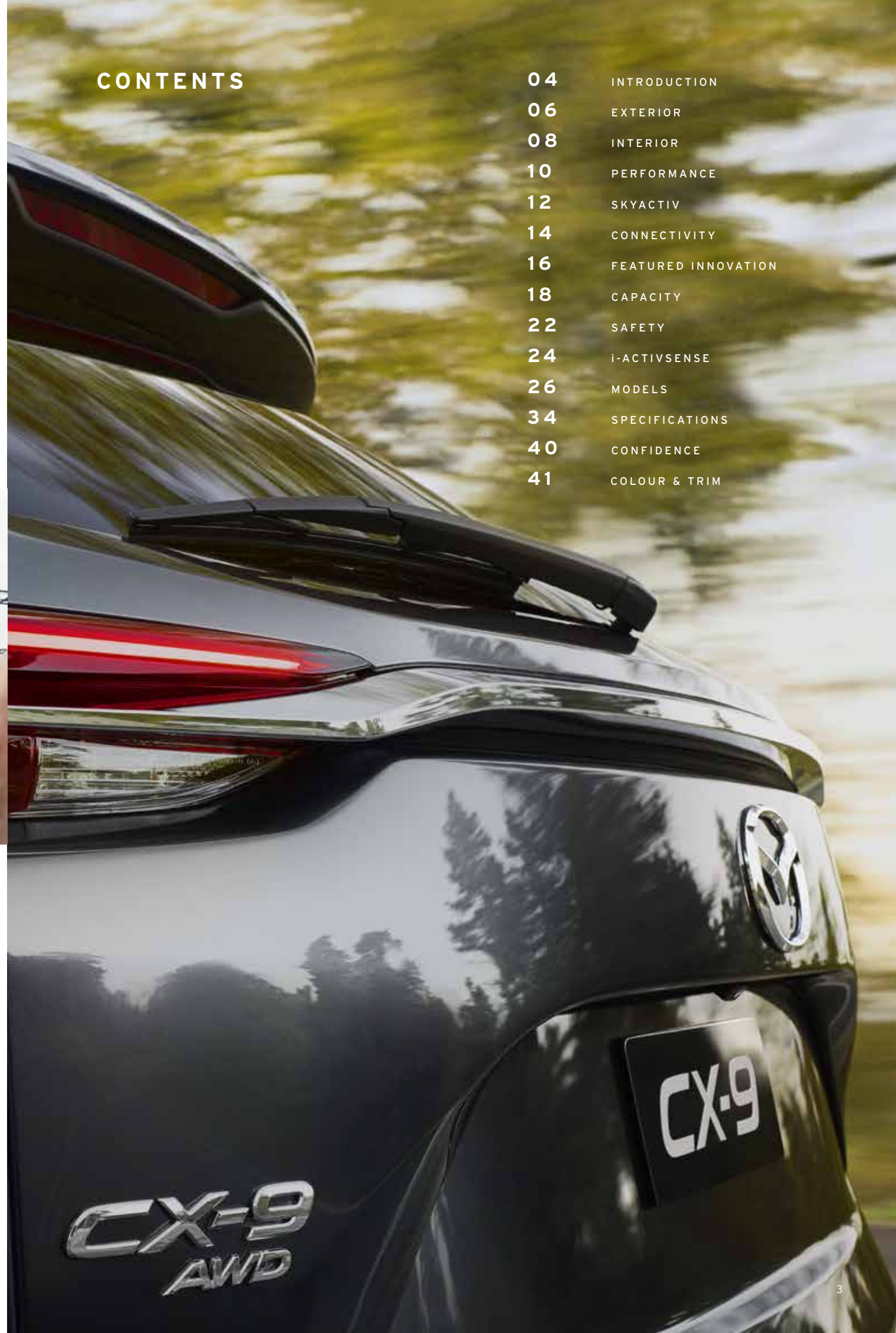



## LUXURY AND PRACTICALITY COME TOGETHER

Mazda CX-9 is the ultimate blend of stunning sophistication and family SUV. Reimagined from the ground up, it's the very first Mazda to feature the breakthrough SKYACTIV-G 2.5T petrol engine. Delivering impressive performance with real-world efficiency, the 2.5-litre direct injection turbocharged engine offers driving excitement never before felt in a family SUV.

Mazda CX-9 cuts an elegant figure on the road thanks to the superb styling of 'KODO - Soul of Motion' design. The spacious interior is finished with quality craftsmanship that is evident in every detail. Add to that the latest in connectivity, passenger comforts and advanced i-ACTIVSENSE safety technology and you've got an SUV that brings together luxury and practicality in a package that your family will love, but you'll love even more.

# NOVAALU



魂動

KODO : SOUL of MOTION

Azami in Machine Grey Metallic.

## ARRIVE IN STYLE

The superb styling of Mazda CX-9 redefines the seven-seat family SUV. Featuring stunning 'KODO - Soul of Motion' design, the bold yet elegant lines command a striking street presence.

Mazda CX-9's confident front grille and strong, stable lower body give it an assured stance on the road. Impressive 20-inch wheels further enhance the look, while integrated LED headlights and tail lights add a sleekness you wouldn't expect in a family SUV.





Azami in Natural stone leather.\*



## NEW LEVELS OF SOPHISTICATION

Mazda CX-9 indulges every passenger with unprecedented comfort, technology and spaciousness. Every element of the cabin features exceptional design and superb craftsmanship.

The elegantly finished cockpit envelops the driver with thoughtfully positioned controls, while the front passenger is surrounded in style. The middle and rear passengers are accommodated in full comfort, with plush seating and ample legroom.

\* Leather interior includes some Maztex material on selected high impact surfaces.





## **BREAKTHROUGH FAMILY SUV PERFORMANCE**

Mazda CX-9 is the very first Mazda to feature the breakthrough SKYACTIV-G 2.5T petrol engine. This 2.5-litre direct injection turbocharged engine delivers an athletic driving performance that's previously unheard of in a family SUV.

Enjoy powerful acceleration and an excellent response in the low-to-mid rpm range without turbo lag. This traditional problem has been overcome by the Dynamic Pressure Turbo - a world-first turbocharging system that adapts its processes according to engine speed.

The addition of intelligent i-ACTIV AWD monitors and even predicts road conditions so CX-9 can adjust its performance to deliver exceptional real-world fuel efficiency and a superior drive every time.

## POWER AND EFFICIENCY

Mazda CX-9 delivers breakthrough performance with a newly-developed, top-of-the-range engine bringing new levels of driving pleasure. The smooth ride and athletic responses come from the latest advances in SKYACTIV TECHNOLOGY, of which CX-9 boasts the full suite. Unleashing exceptional efficiency, clever technologies like i-ELOOP have found even more ways to save on fuel and emissions.

Mazda CX-9 now introduces SKYACTIV-VEHICLE DYNAMICS, a series of technologies that integrates control of the engine, transmission, chassis and body to enhance the sense of oneness between car and driver that we call Jinba Ittai.

\*Combined fuel consumption figures are based on ADR 81/02 test results. They are useful in comparing the fuel consumption of different vehicles. They may not be the fuel consumption achieved in practice. This will depend on traffic, road conditions and how the vehicle is driven.



### SKYACTIV-G 2.5T ENGINE

The ground-breaking new petrol engine delivers the torque of a 4.0 litre V8, yet does so with impressive fuel efficiency from 8.4 litres of fuel per 100km\*. It offers excellent dynamic performance in the mid-to-low rpm range, which is where the majority of everyday driving occurs.

World-first Dynamic Pressure Turbo controls the degree of exhaust pulsation depending on engine speed. Driven by a constant pressure flow at higher rpms, the system reroutes the energy in every exhaust pulsation to maximise drive force at lower rpms. This means you get turbocharged performance, without the lag.



### i-ACTIV AWD INTELLIGENT ALL-WHEEL DRIVE SYSTEM

Mazda's i-ACTIV AWD is a predictive, on-demand AWD system that anticipates front tyre slip and applies just enough torque to the rear wheels to prevent slipping from occurring. It does this via 27 sensors, which constantly monitor the road surface, outside conditions, driver operation and vehicle condition. Analysing this information 200 times per second, the system helps ensure a stress-free drive in a wide range of conditions.



### SKYACTIV-DRIVE AUTOMATIC TRANSMISSION

Features an expanded lock-up range for efficiency and direct feel. Drivers can switch between Sports Mode or manual shift for more hands-on input.



### i-ELOOP

Mazda's unique brake energy regeneration system captures braking energy in a capacitor that then reroutes that energy to power various electrical systems. On top of reducing fuel consumption, the capacitor charges and discharges faster than conventional battery systems.

Intelligent i-stop saves even more fuel by switching off the engine when you come to a standstill, restarting the moment you accelerate.



### SKYACTIV-BODY

The new-generation features an advanced body, making it lighter and more rigid than ever for superior handling. Increased use of high-tensile steel saves on weight while increasing strength. The exceptional new design also results in a quieter, more premium ride thanks to sound-absorbent materials, improved door seals and sound-insulating glass.



### SKYACTIV-CHASSIS

Passengers experience a smooth, comfortable ride thanks to strut suspension in the front and multi-link suspension in the rear. The angle of the dampers has been optimised and solid rear bushings in the front have been replaced with a liquid variety that provides superior ratios of stiffness and compliance. These enhancements noticeably reduce the overall feeling of road vibration for optimum passenger comfort.



## BE SURROUNDED BY SUPERIOR SOUND

Be immersed in the exceptional sound quality of Bose® audio (available on GT and above). The 12-speaker system is integrated seamlessly throughout Mazda CX-9's luxurious interior. Listen to music, radio and podcasts from a wide range of sources, including Stitcher™ and Aha™. Enjoy access to all your favourite audio web content when connected to a compatible smartphone.<sup>§</sup>

<sup>§</sup> Please check the compatibility of your Bluetooth® device (particularly your mobile phone) with the specific Mazda vehicle you intend to purchase as not all devices operate correctly. Visit [www.mazda.com.au/Bluetooth](http://www.mazda.com.au/Bluetooth) or consult your Mazda Dealer for further information.



## CONNECTIVITY THAT COMES WITH YOU

Mazda CX-9 is fully-equipped to handle the entertainment demands of modern families, offering the latest in connectivity and infotainment. Four USB ports are distributed throughout the cabin to accommodate all your devices. Up front, MZD Connect allows you to safely access your compatible smartphone's<sup>§</sup> contacts, social media and music, while Sat Nav guides you from a large, upright touchscreen controlled by a central dial.



Azami in Black leather.\*

## DRIVEN BY INNOVATION

Mazda CX-9 incorporates clever design and intelligent features that enhance the pure driving enjoyment. Stylishly integrated LED headlights and tail lights are standard, perfectly complementing the sleek, sculpted exterior.

Active Driving Display is projected onto the windscreen in full colour (available on GT and above), displaying trip information in your line of sight for a less distracted drive†. In another first, Mazda CX-9 features Mazda Radar Cruise Control (MRCC) with Stop & Go function. MRCC reduces the stress of negotiating heavy traffic by automatically adjusting vehicle speed to maintain a safe distance from the car ahead. It's details like these that make CX-9 captivating for the driver and passengers alike.

\* Leather interior includes some Maztex material on selected high impact surfaces.

† i-ACTIVSENSE, other safety technologies and driver-assistance features do not replace the driver's judgment, and should not be used in place of skilled and safe driving practices. It is the driver's sole responsibility to monitor vehicle surroundings and conditions and comply with all applicable laws at all times.

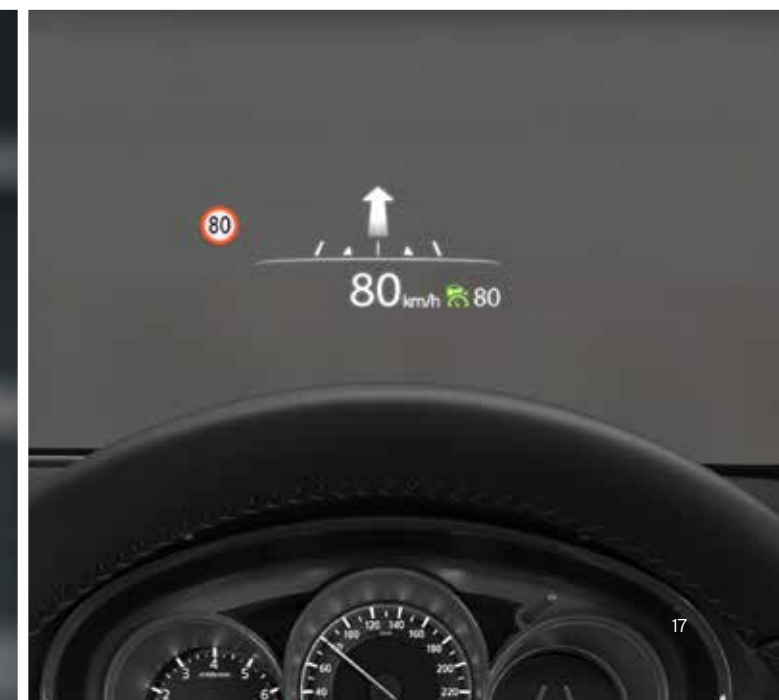



Azami in Natural stone leather.\*



## ADAPTS TO YOUR LIFESTYLE

Mazda CX-9 effortlessly accommodates the daily demands of the modern family with a versatile cabin that adapts to all your seating and luggage requirements. The third-row is accessed using a mechanic so simple even children can operate it, while added storage space is integrated throughout the cabin to keep clutter stowed neatly out of sight. The addition of USB ports in the second row enables everyone to keep their devices powered. Mazda CX-9 is also equipped with three-zone climate control, ensuring every passenger travels in comfort.

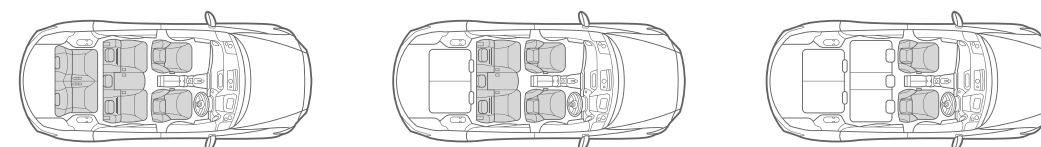

\* Leather interior includes some Maztex material on selected high impact surfaces.



**STUNNING SOPHISTICATION  
MEETS FAMILY SUV**



## PROTECT YOUR MOST PRECIOUS CARGO

Mazda CX-9 is designed to maximise the safety of every single passenger on board.

The driving environment features excellent visibility, with well-positioned controls to minimise driver distraction† Reverse camera and rear-parking sensors offer extra peace of mind, while the latest advanced braking technologies are fitted to assist you in emergency situations.

Built with a rigid body cell, every grade comes equipped as standard with SRS airbags and technology like Hill Launch Assist. Mazda CX-9 puts your family's safety first, so you can experience true driving confidence.



Azami in Machine Grey Metallic.

† Driver-assistance features do not replace the driver's judgment and are not to be used in place of skilled and safe driving practices. It is the driver's sole responsibility to monitor vehicle surroundings and conditions and comply with all applicable laws at all times.

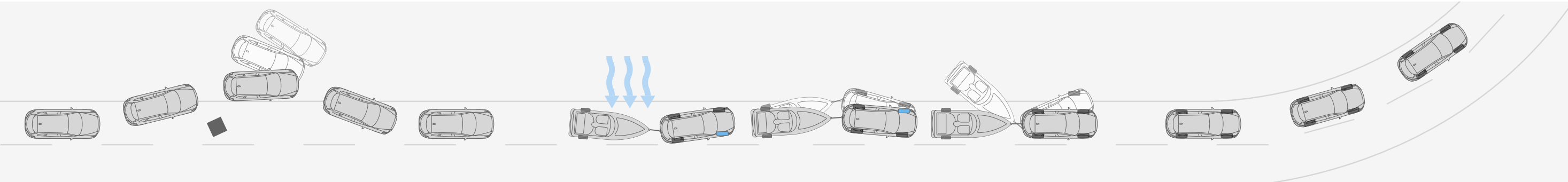

### READY TO REACT

If unexpected hazards appear suddenly, Dynamic Stability Control (DSC) acts instantly, braking the inner rear wheel to offset understeer (or outer front wheel to combat oversteer). The Traction Control System (TCS) also reduces torque to the driven wheels to minimise skidding. The hazard can be steered around, as control is maintained.

### SAFETY REFLEX

Trailer Stability Assist (TSA) adjusts braking and torque to correct any side-to-side swinging movement of towed loads.

### ENJOY THE RIDE

By finely controlling engine torque based on the steering and accelerator inputs of the driver, G-Vectoring Control (GVC) improves both handling for the driver and ride quality for the passengers around corners.

## ADVANCED SAFETY TECHNOLOGY LOOKS OUT FOR YOU

Mazda CX-9 comes equipped with a suite of advanced i-ACTIVSENSE safety technologies as standard. i-ACTIVSENSE assists the driver to avoid potential hazards. Along with preventative features, crash-severity-reduction technology is activated in the event of unavoidable impact.

Mazda CX-9 is the first ever Mazda to feature Mazda Radar Cruise Control (MRCC) with Stop & Go function, which reduces the stress of negotiating heavy stop-start traffic.

† i-ACTIVSENSE and other safety technologies are driver assist technologies only and should not be used in place of skilled and safe driving practices. It is the driver's sole responsibility to monitor vehicle surroundings and conditions and comply with all applicable laws at all times.



### BLIND SPOT MONITORING (BSM)

By scanning external mirrors' blind spots, radars detect any unseen vehicles to alert the driver of hazardous lane changes. An LED icon on the relevant mirror is accompanied by beeping alerts.

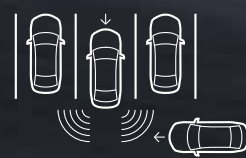

### REAR CROSS TRAFFIC ALERT (RCTA)

RCTA assists you when you're reversing from a parking space, warning if a car is approaching from either side of your vehicle. The LED icon on both mirrors is accompanied by a beeping alert.



### SMART CITY BRAKE SUPPORT WITH PEDESTRIAN RECOGNITION (SCBS)

At forward speeds of 4-80km/h (and reverse speeds of 2-8km/h) SCBS monitors the vehicle or pedestrian in front to assess the likelihood of a collision. If a high risk is detected it issues visible and audio warnings and primes the brakes for a faster response. If the driver doesn't brake, SCBS brakes automatically.



### MAZDA RADAR CRUISE CONTROL (MRCC) WITH STOP & GO FUNCTION

MRCC automatically adjusts vehicle speed to maintain a safe distance from the car ahead. It's able to bring the car to a complete stop in traffic and take off again once traffic moves (if the stop is less than 3 seconds). If a complete stop exceeds 3 seconds, the car waits for the driver to initiate acceleration. Standard on Azami.



### ADAPTIVE LED HEADLAMPS (ALH)

Individual control of several LEDs allows precise adjustment of the lighting pattern. The system automatically broadens visibility at low speeds, shapes the high beam to help avoid dazzling other drivers and raises beam height at highway speeds to extend vision area. Standard on Azami.



### TRAFFIC SIGN RECOGNITION (TSR)

TSR detects a number of road signs which are in turn displayed on the vehicle's Active Driving Display. The types of signs that could be displayed to warn you include speed limit signs, "do not enter" signs and stop signs. Standard on GT and Azami.



### LANE DEPARTURE WARNING (LDW) WITH LANE-KEEP ASSIST SYSTEM (LAS)

LDW uses a windscreen-mounted camera to monitor road lane markings, sounding an audible warning if you're about to stray from your lane. LAS will act if it determines the vehicle will leave its lane by applying a degree of corrective steering. Standard on Azami.



### SMART BRAKE SUPPORT (SBS)

Operating at 15-160km/h, SBS monitors the distance to and speed of the vehicle in front. If SBS senses a high risk of impact, it primes the brakes for faster response. If you take evasive action, SBS deactivates. If no evasive action is taken, the brakes are applied automatically. Standard on Azami.



# CX-9

## SPORT



Sport in Deep Crystal Blue Mica.

### SPORT FEATURES

- » 18-inch alloy wheels (dark-silver) with 255/60 tyres
- » Headlamps (LED)
- » Power mirrors (body-coloured with heating and auto-folding function)
- » Air-conditioning (three-zone climate control) with independent rear control
- » Rear-view mirror with auto dimming function
- » Seat trim: Black cloth
- » 7-inch touch screen display (MZD Connect)
- » Audio system with: AM/FM tuner, Digital radio (DAB+) and 6 speakers
- » Bluetooth® hands-free phone and audio capability<sup>§</sup>
- » Internet radio integration (Stitcher™ and Aha™)
- » Multi-function commander control
- » Satellite navigation
- » Advanced keyless push button engine start
- » Blind Spot Monitoring (BSM)
- » Driver Attention Alert (DAA)
- » Parking sensors (rear)
- » Rear Cross Traffic Alert (RCTA)
- » Reverse camera
- » Smart City Brake Support [Forward/Reverse] (SCBS F/R)

### POWERTRAIN

#### SKYACTIV-G 2.5T

- » 2.5 litre in-line 4 cylinder 16 valve DOHC S-VT turbo petrol engine with i-stop and i-ELOOP
- » Drivetrain: FWD or i-ACTIV AWD
- » Fuel consumption (combined): 8.4L/100km\* (FWD) or 8.8L/100km\* (AWD)
- » Max power: 170kW @ 5,000rpm
- » Max torque: 420Nm @ 2,000rpm
- » Transmission: 6-speed auto (SKYACTIV-Drive)

<sup>§</sup> Please check the compatibility of your Bluetooth® device (particularly your mobile phone) with the specific Mazda vehicle you intend to purchase as not all devices operate correctly. Visit [www.mazda.com.au/Bluetooth](http://www.mazda.com.au/Bluetooth) or consult your Mazda Dealer for further information.

\* Combined fuel consumption figures are based on ADR 81/02 test results. They are useful in comparing the fuel consumption of different vehicles. They may not be the fuel consumption achieved in practice. This will depend on traffic, road conditions and how the vehicle is driven.



#### PERSONALISED COMFORT

Three-zone climate control allows temperature throughout the cabin to be adjusted for every passenger.



#### SAFELY SWITCH LANES

Blind Spot Monitoring warns of hazardous lane changes with LED icons and beeping alerts.



#### CONTROL YOUR WORLD

The large 7-inch colour touchscreen makes MZD Connect and satellite navigation easy to operate.



#### EXTRA SENSES

Rear camera and rear parking sensors give you added confidence while reversing.



Touring in Snowflake White Pearl Mica.

## TOURING FEATURES

### ADDITIONAL TO SPORT

- » Bright alloy wheels
- » Front fog-lamps (LED)
- » Headlamps auto on/off function
- » Wipers front 2-speed with rain-sensing function
- » Front seats with: 6-way power adjustment (passenger), 8-way power adjustment (driver) and heating function
- » Rear seats with: Centre armrest storage and USB input ports (2nd row)
- » Seat trim: Black leather\*
- » 8-inch touch screen display (MZD Connect)
- » Advanced keyless entry

## POWERTRAIN

### SKYACTIV-G 2.5T

- » 2.5 litre in-line 4 cylinder 16 valve DOHC S-VT turbo petrol engine with i-stop and i-ELOOP
- » Drivetrain: FWD or i-ACTIV AWD
- » Fuel consumption (combined): 8.4L/100km\* (FWD) or 8.8L/100km\* (AWD)
- » Max power: 170kW @ 5,000rpm
- » Max torque: 420Nm @ 2,000rpm
- » Transmission: 6-speed auto (SKYACTIV-Drive)

\* Leather interior includes some Maztex material on selected high impact surfaces.

\* Combined fuel consumption figures are based on ADR 81/02 test results. They are useful in comparing the fuel consumption of different vehicles. They may not be the fuel consumption achieved in practice. This will depend on traffic, road conditions and how the vehicle is driven.



### SHINE ON

Bright Alloys add dynamic edge with their sharp, bold design and high-gloss finish.



### MAKES LIGHT WORK

Auto on-off headlamps mean one less thing to think about while driving in changing light conditions.

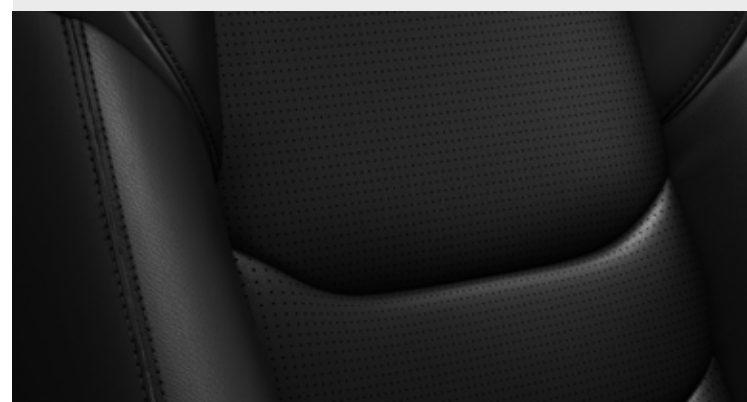

### A CUT ABOVE

Luxurious leather\* seats in sleek black are timelessly elegant.



### STAY IN TOUCH

Large 8-inch communication touchscreen puts MZD Connect infotainment at your fingertips.

# CX-9

## GT



GT in Soul Red Crystal Metallic.

### GT FEATURES

#### ADDITIONAL TO TOURING

- » 20-inch alloy wheels with 255/50 tyres
- » Remote operated power tailgate (open/close)
- » Power sliding and tilt glass sunroof
- » Active Driving Display
- » Front seats with: 2-position memory function (driver) and 10-way power adjustment (driver)
- » Rear seats with: heating function (2nd row outer)
- » Seat trim: Black or Natural stone leather\*
- » Premium Bose® 294 watt amplifier and 12 speakers (including subwoofer)
- » Parking sensors (front)
- » Traffic Sign Recognition (TSR)

### POWERTRAIN

#### SKYACTIV-G 2.5T

- » 2.5 litre in-line 4 cylinder 16 valve DOHC S-VT turbo petrol engine with i-stop and i-ELOOP
- » Drivetrain: FWD or i-ACTIV AWD
- » Fuel consumption (combined): 8.4L/100km\* (FWD) or 8.8L/100km\* (AWD)
- » Max power: 170kW @ 5,000rpm
- » Max torque: 420Nm @ 2,000rpm
- » Transmission: 6-speed auto (SKYACTIV-Drive)

# Leather interior includes some Maztex material on selected high impact surfaces.

\* Combined fuel consumption figures are based on ADR 81/02 test results. They are useful in comparing the fuel consumption of different vehicles. They may not be the fuel consumption achieved in practice. This will depend on traffic, road conditions and how the vehicle is driven.



#### STUNNING SOUND

A 12-speaker system ensures every passenger enjoys the premium Bose® audio experience.



#### PARK WITH EASE

Enjoy the added confidence of front parking sensors alerting the distance to objects in front.



#### HANDS-FREE ACCESS

Power liftgate conveniently lifts the tailgate with the push of a button when your hands are full.



#### HEADS UP

Full colour Active Driving Display projects important driving information onto the windscreen into your line of sight.



Azami in Machine Grey Metallic.

## AZAMI FEATURES

### ADDITIONAL TO GT

- » Mazda Radar Cruise Control (MRCC) with Stop & Go function
- » Adaptive LED Headlamps (ALH)
- » Lane Departure Warning (LDW)
- » Lane-keep Assist System (LAS)
- » Smart Brake Support (SBS)

## POWERTRAIN

### SKYACTIV-G 2.5T

- » 2.5 litre in-line 4 cylinder 16 valve DOHC S-VT turbo petrol engine with i-stop and i-ELOOP
- » Drivetrain: FWD or i-ACTIV AWD
- » Fuel consumption (combined): 8.4L/100km\* (FWD) or 8.8L/100km\* (AWD)
- » Max power: 170kW @ 5,000rpm
- » Max torque: 420Nm @ 2,000rpm
- » Transmission: 6-speed auto (SKYACTIV-Drive)

\* Combined fuel consumption figures are based on ADR 81/02 test results. They are useful in comparing the fuel consumption of different vehicles. They may not be the fuel consumption achieved in practice. This will depend on traffic, road conditions and how the vehicle is driven.

† Leather interior includes some Maztex material on selected high impact surfaces.

‡ i-ACTIVSENSE and other safety technologies are driver assist technologies only and should not be used in place of skilled and safe driving practices. It is the driver's sole responsibility to monitor vehicle surroundings and conditions and comply with all applicable laws at all times.



### TOUCH THE SKY

Power-operated sliding glass sunroof with tilt function unites the interior with the sky.



### SAFE DISTANCE

Mazda Radar Cruise Control with Stop & Go function automatically adjusts speed to maintain a safe distance from the car ahead, even in heavy traffic†



### LUXURIOUS LEATHER

Beautifully crafted natural stone leather† seat trim with impeccable stitching adds understated appeal.



### LANE LOOKOUT

Lane Departure Warning (LDW) and Lane-keep Assist System (LAS) alert you if you unintentionally stray from your lane!†

# SPECIFICATIONS

Powertrain		2.5L Turbo I4 Petrol FWD	2.5L Turbo I4 Petrol AWD
Bore and stroke (mm)		89.0 x 100.0	89.0 x 100.0
Compression ratio		10.5 : 1	10.5 : 1
Drivetrain		FWD	i-ACTIV AWD
Emissions standard		Euro stage V	Euro stage V
Engine capacity (cc)		2,488	2,488
Engine type		2.5 litre turbo in-line 4 cylinder 16 valve DOHC S-VT petrol (SKYACTIV-G 2.5T) engine	2.5 litre turbo in-line 4 cylinder 16 valve DOHC S-VT petrol (SKYACTIV-G 2.5T) engine
Fuel consumption (l/100km)*:	Auto (combined)	8.4	8.8
	Auto (extra urban)	6.9	7.3
	Auto (urban)	11.0	11.4
Fuel system		Electronic direct injection	Electronic direct injection
Fuel tank capacity (litres)		72	74
Gear ratio:	1st	3.487	3.487
	2nd	1.992	1.992
	3rd	1.449	1.449
	4th	1.000	1.000
	5th	0.707	0.707
	6th	0.600	0.600
	Reverse	3.990	3.990
	Final drive	4.411	4.411
Maximum power (kW @ rpm)		170 @ 5,000	170 @ 5,000
Maximum torque (Nm @ rpm)		420 @ 2,000	420 @ 2,000
Recommended fuel		Unleaded (91RON or higher) or E10	Unleaded (91RON or higher) or E10
Throttle control		Electronic (drive-by-wire)	Electronic (drive-by-wire)
Transmission		6-speed (SKYACTIV-Drive) Automatic	6-speed (SKYACTIV-Drive) Automatic

Model Availability		Sport	Touring	GT	Azami
7-seat SUV:	2.5L Turbo I4 Petrol FWD / 6-speed automatic	●	●	●	●
	2.5L Turbo I4 Petrol AWD / 6-speed automatic	●	●	●	●

Chassis and Powertrain Technologies	Sport	Touring	GT	Azami
Automatic transmission drive selection	●	●	●	●
Automatic transmission kickdown switch	●	●	●	●
Dynamic Pressure Turbo system	●	●	●	●
Electric Parking Brake	●	●	●	●
Electric power assist steering	●	●	●	●
Hill Launch Assist (HLA)	●	●	●	●
i-ACTIV AWD	○	○	○	○
i-ELOOP	●	●	●	●
i-stop	●	●	●	●
SKYACTIV-BODY	●	●	●	●
SKYACTIV-CHASSIS	●	●	●	●
SKYACTIV-VEHICLE DYNAMICS G-Vectoring Control (GVC)	●	●	●	●

Chassis		Sport	Touring	GT	Azami
Brake diameter (mm):	Front	----- 320 -----			
	Rear	----- 325 -----			
Brake type:	Front	----- Ventilated disc -----			
	Rear	----- Solid disc -----			
Suspension:	Front	----- MacPherson strut -----			
	Rear	----- Multi-link -----			
Turning circle kerb to kerb (m)		----- 11.8 -----			
Tyre size		255/60 R18	255/60 R18	255/50 R20	255/50 R20
Tyre index		108H	108H	105V	105V
Wheel size		18 x 8.0 J	18 x 8.0 J	20 x 8.5 J	20 x 8.5 J
Wheel type		----- Alloy -----			
Tyre size (spare)		----- 185/80 R17 -----			
Wheel size (spare)		----- 17 x 5.5 J -----			
Wheel type (spare)		----- Temporary (Steel) -----			

Weights and Capacities		Sport	Touring	GT	Azami
Cargo volume VDA (litres). Measured with 3rd row seats up and up to roof.		230	230	230	230
Cargo volume VDA (litres). Measured with 3rd row seats folded down and up to roof.		810	810	810	810
Kerb weight (kg):	2.5L Turbo I4 Petrol FWD / 6-speed automatic	1,845	1,845	1,907	1,907
	2.5L Turbo I4 Petrol AWD / 6-speed automatic	1,913	1,913	1,974	1,974
Towing capacity <sup>x</sup> (kg):	Braked	2,000	2,000	2,000	2,000
	Unbraked	750	750	750	750
Tow ball download maximum (kg)		100	100	100	100

● = Standard, ○ = Option.

\* Combined fuel consumption figures are based on ADR 81/02 test results. They are useful in comparing the fuel consumption of different vehicles. They may not be the fuel consumption achieved in practice. This will depend on traffic, road conditions and how the vehicle is driven.

<sup>x</sup> When fitted with a Mazda Genuine Towing kit. Subject to State and Territory regulations.

Dimensions		Sport	Touring	GT	Azami
Ground clearance (mm):	Laden	220	220	220	220
	Unladen	222	222	222	222
Overall length (mm)		5,075	5,075	5,075	5,075
Overall width (mm)		1,969	1,969	1,969	1,969
Overall height (mm)		1,747	1,747	1,747	1,747
Track (mm):	Front	1,663	1,663	1,663	1,663
	Rear	1,663	1,663	1,663	1,663
Wheelbase (mm)		2,930	2,930	2,930	2,930

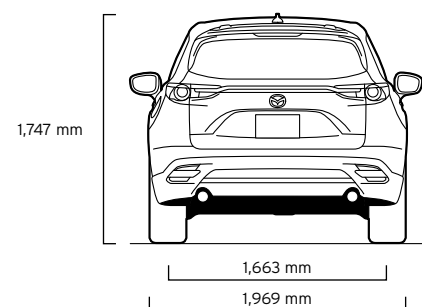
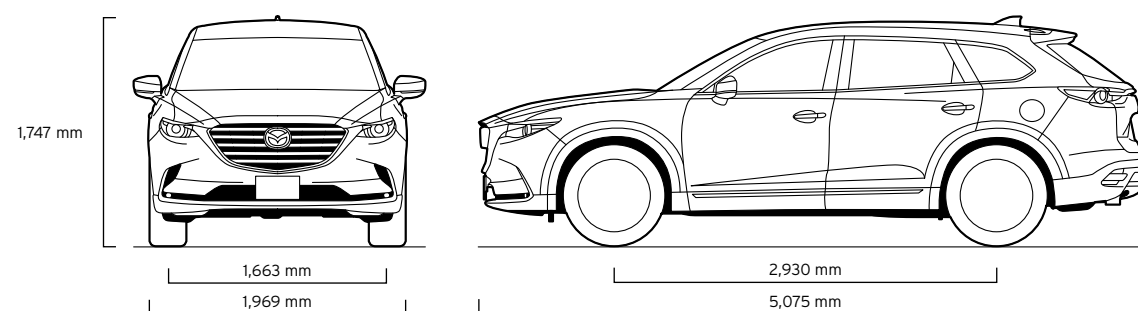

Exterior	Sport	Touring	GT	Azami
Daytime running lamps (Halogen)	●	●	●	–
Daytime running lamps (LED)	–	–	–	●
Door handles (body coloured)	●	●	●	●
Exhaust extensions (chrome)	●	●	●	●
Front fog-lamps (LED)	–	●	●	●
Front and rear bumpers (body coloured)	●	●	●	●
Green-tinted windscreen, side and rear windows	●	●	●	●
Headlamps (LED)	●	●	●	●
Headlamps auto on/off function	–	●	●	●
Power mirrors (body coloured with heating and auto-folding function)	●	●	●	●
Power sliding and tilt glass sunroof	–	–	●	●
Power windows	●	●	●	●
Rear spoiler	●	●	●	●
Remote operated power tailgate (open/close)	–	–	●	●
Tail-lamps (LED)	●	●	●	●
Window demister (rear)	●	●	●	●
Wipers (front) 2-speed with rain-sensing function	–	●	●	●
Wipers (front) 2-speed with variable intermittent function	●	–	–	–
Wiper (rear) with intermittent function	●	●	●	●

Seats	Sport	Touring	GT	Azami	
Front seats with:	2-position memory function (driver)	–	–	●	●
	6-way power adjustment (passenger)	–	●	●	●
	8-way power adjustment (driver)	–	●	–	–
	10-way power adjustment (driver)	–	–	●	●
	Adjustable head restraints	●	●	●	●
	Heating function	–	●	●	●
	Height adjustment	●	●	●	●
	Lumbar support adjustment (driver)	–	●	●	●
	Rake and slide adjustment	●	●	●	●
	Seat back pockets	●	●	●	●
Rear seats with:	60/40 split fold backrest (2nd row)	●	●	●	●
	50/50 split fold backrest (3rd row)	●	●	●	●
	Adjustable head restraints	●	●	●	●
	Centre fold down armrest (2nd row)	●	–	–	–
	Centre fold down armrest with USB and storage (2nd row)	–	●	●	●
	Heating function (2nd row outer)	–	–	●	●
	Rake and slide adjustment (2nd row)	●	●	●	●
Seat trim:	Black cloth	●	–	–	–
	Black leather#	–	●	●	●
	Natural stone leather#	–	–	○	○

● = Standard, ○ = Option, – = Not available.

# SPECIFICATIONS

Interior	Sport	Touring	GT	Azami
Active Driving Display (with two position memory)	–	–	●	●
Air-conditioning (three-zone climate control) with independent rear control and vents (2nd row)	●	●	●	●
Ambient temperature display	●	●	●	●
Cargo area 12 volt power outlet	●	●	●	●
Centre armrest console	●	●	●	●
Critical function warning lights/chimes	●	●	●	●
Cruise control	●	●	●	●
Mazda Radar Cruise Control (MRCC) with Stop & Go function	–	–	–	●
Cupholders	●	●	●	●
Door bottle holders (front and rear)	●	●	●	●
Glove box	●	●	●	●
Instrument panel light dimmer	●	●	●	●
Interior illumination:				
Cargo room lamp	●	●	●	●
Entry system with delayed fade	●	●	●	●
Map reading spot lamps (Incandescent)	●	●	–	–
Map reading spot lamps (LED)	–	–	●	●
Power window switch	●	●	●	●
Leather-wrapped:				
Gear shift knob	●	●	●	●
Steering wheel	●	●	●	●
One touch (up and down) power windows (front and rear)	●	●	●	●
Overhead sunglass storage box	●	●	●	●
Rear door window sunshade	–	–	●	●
Rear-view mirror with auto dimming function	●	●	●	●
Tachometer and electronic odometer/tripmeter	●	●	●	●
Tilt and telescopic adjustable steering wheel	●	●	●	●
Trip computer	●	●	●	●
Vanity mirrors (front) with illumination	●	●	●	●

Infotainment	Sport	Touring	GT	Azami
7-inch full colour touch screen display (MZD Connect)	●	–	–	–
8-inch full colour touch screen display (MZD Connect)	–	●	●	●
AM/FM tuner	●	●	●	●
Auxiliary-audio input jack (3.5mm mini-stereo)	●	●	●	●
Bluetooth® hands-free phone and audio capability <sup>§</sup>	●	●	●	●
Digital radio (DAB+)	●	●	●	●
Internet radio integration (Stitcher™ and Aha™)	●	●	●	●
Multi-function commander control	●	●	●	●
Premium Bose® 294 watt amplifier and speakers	–	–	●	●
Radio Data System (RDS) program information	●	●	●	●
Satellite navigation	●	●	●	●
Speakers (6)	●	●	–	–
Speakers (12)	–	–	●	●
Steering wheel-mounted audio controls	●	●	●	●
USB-audio input port (iPod® compatible)	●	●	●	●

Safety and Security	Sport	Touring	GT	Azami
Adaptive LED Headlamps (ALH)	–	–	–	●
Blind Spot Monitoring (BSM)	●	●	●	●
Advanced keyless entry	–	●	●	●
Advanced keyless push-button engine start	●	●	●	●
Airbags SRS:				
Front (driver and passenger)	●	●	●	●
Side (front)	●	●	●	●
Curtain (front and rear)	●	●	●	●
Anti-lock Braking System (ABS)	●	●	●	●
Auto Door Lock (ADL)	●	●	●	●
Childproof rear door locks	●	●	●	●
Child restraint anchorage points:				
ISOFIX (x2)	●	●	●	●
Top tether (x5)	●	●	●	●
Driver Attention Alert (DAA)	●	●	●	●
Dynamic Stability Control (DSC)	●	●	●	●
Electronic Brake-force Distribution (EBD)	●	●	●	●
Emergency Brake Assist (EBA)	●	●	●	●
Emergency Stop Signal (ESS)	●	●	●	●
Engine immobiliser	●	●	●	●
Forward Obstruction Warning (FOW)	–	–	–	●
High mount stop lamp	●	●	●	●
Hill Launch Assist (HLA)	●	●	●	●
Intrusion-minimising brake pedal	●	●	●	●
Lane-keep Assist System (LAS)	–	–	–	●
Lane Departure Warning (LDW)	–	–	–	●
Left-hand-side convex (wide angle) exterior mirror	●	●	●	●
Parking sensors (front)	–	–	●	●
Parking sensors (rear)	●	●	●	●
Rear Cross Traffic Alert (RCTA)	●	●	●	●
Remote central locking (2 transmitters)	●	●	●	●
Reverse camera	●	●	●	●
Roll Stability Control (RSC)	●	●	●	●
Seat-belt warning (front and rear)	●	●	●	●
Seat-belts 3-point lap-sash (all seats)	●	●	●	●
Seat-belts (front) with pretensioners, load-limiters and height adjustable shoulder anchorages	●	●	●	●
Seat-belts (2nd row) with pretensioners and load-limiters	●	●	●	●
Side impact door beams	●	●	●	●
Smart Brake Support (SBS)	–	–	–	●
Smart City Brake Support [Forward/Reverse] (SCBS F/R)	●	●	●	●
Traction Control System (TCS)	●	●	●	●
Trailer Stability Assist (TSA)	●	●	●	●
Traffic Sign Recognition (TSR)	–	–	●	●
*Triple H* safety construction with front and rear crumple zones	●	●	●	●
Whiplash-minimising front seats	●	●	●	●

● = Standard, – = Not available.

## ENJOY MAZDA CX-9 WITH CONFIDENCE



### REST ASSURED – YOUR WARRANTY

The quality built into Mazda CX-9 is backed up by a 3-year, unlimited kilometre factory warranty and 6-year panel protection warranty.

### MAINTAIN THAT ZOOM-ZOOM

Your Mazda CX-9 deserves the best in care. Servicing with Mazda Service Select gives your car the advantage of factory trained Service Technicians and advanced computer diagnostic systems. As well as maintaining your Mazda in A1 condition, you'll also be protecting your vehicle's outstanding resale value.

### HELP IS AT HAND – MAZDA ROADSIDE ASSISTANCE

Flat batteries, running out of fuel, flat tyres – everyone faces hiccups from time to time. When the unexpected happens, Mazda Roadside Assistance is there to keep you moving. You'll be covered 24 hours a day, 365 days a year, all round Australia. Better still, your Mazda will only be worked on by Mazda-approved technicians. Choose a Standard policy offering everything needed to get going again, or Premium with extras like accommodation, a rental car and vehicle recovery. Either can be purchased across the entire Mazda range. (Terms and conditions apply)



## MAZDA CX-9 COLOUR AND TRIM

### BODY COLOURS



Snowflake White Pearl Mica



Sonic Silver Metallic



Soul Red Crystal Metallic<sup>■</sup>



Machine Grey Metallic<sup>■</sup>



Titanium Flash Mica<sup>■</sup>



Deep Crystal Blue Mica<sup>■</sup>



Jet Black Mica<sup>■</sup>

### INTERIOR TRIMS

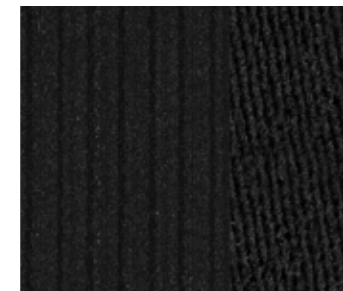

Black cloth  
(Sport)



Black leather<sup>#</sup>  
(Touring, GT and Azami)

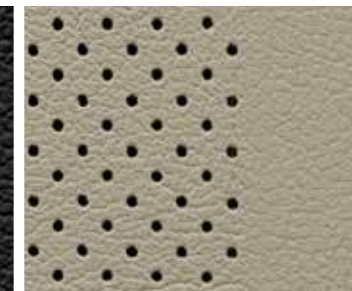

Natural stone leather<sup>#■</sup>  
(GT and Azami)

<sup>^</sup> At extra cost.

<sup>■</sup> Natural stone leather interior only available with Soul Red Crystal Metallic, Machine Grey Metallic, Titanium Flash Mica, Deep Crystal Blue Mica and Jet Black Mica exterior colours.

<sup>#</sup> Leather interior includes some Maztex material on selected high impact surfaces.

All care is taken to ensure the accuracy of this brochure and availability of vehicles and features at the time of publication, however, to the extent permitted by law, Mazda Australia Pty Ltd will not be liable for any loss suffered or incurred by a purchaser or prospective purchaser if the content is inaccurate or not up to date, or if it withdraws any vehicles or features referred to in the brochure from the market. Specifications, features and model availability may vary from State to State and may change without notice. Please refer to [mazda.com.au](http://mazda.com.au) or consult your Mazda Dealer prior to placing an order to ascertain current information on model availability, specifications, options, features and prices. Mazda Australia Pty Ltd ABN 78 004 690 804. 211A Wellington Road, Mulgrave, Victoria 3170. iPod is a trademark of Apple Inc., registered in the U.S. and other countries. Due to the nature of the printing process, colours may vary from those shown in this brochure. Ask your Dealer to show you a product sample.



IMAGINATION DRIVES US



Facebook.com/  
MazdaAus



YouTube.com/  
ZoomZoom



Twitter.com/  
MazdaAus



Instagram.com/  
MazdaAus

Published February 2018. MAZ13630 126.035

For further information visit [mazda.com.au](http://mazda.com.au) or Freecall 1800 034 411

*MAZDA  
GENUINE  
ACCESSORIES*

*CX-9*



*ZOOM-ZOOM*



**MAZDA**

## MAKE YOUR MAZDA EVEN MORE REWARDING

Brand-New Mazda CX-9 is the stunning SUV your family will love, but you'll love even more. Mazda Genuine Accessories enhance the luxury styling and practical features, while customising and protecting your investment. Featuring outstanding design, quality, fit and safety, each accessory comes backed by a Mazda Warranty. Mazda Genuine Accessories add extra Zoom-Zoom to your CX-9 and indulge your family even more.



### MOBILE PHONE HOLDER

Safe, stylish and compatible with many popular phones, this gives drivers easy phone visibility and access. Allows for portrait or landscape use.



### REAR SEAT ENTERTAINMENT HOLDER FOR IPAD®

Keep rear seat passengers entertained with this convenient holder for your iPad®.



### CARGO ORGANISER BOX

Prevent items from sliding around in the cargo area. Features moveable internal dividers, detachable lids and a securable base.



### CARGO NET

Restrain smaller cargo items in the load compartment with this easily removable netting.



### FRONT FLOOR MATS

Protect your carpet with these high-quality, tailor-made floor mats. Fastening system enhances safety. (Front and rear sold separately)



### REAR WINDOW SHADES

Provide sun protection for rear passengers and cargo. (Set of two) (Sport and Touring models only)



### CARGO TRAY

A durable, custom-fitted tray with raised edges to protect the load compartment from spills, dirt and scratches.



### BOOT LIP PROTECTOR

Protect your rear bumper and boot lip from scratches and scuffs during loading and unloading.



### FRONT SEAT COVERS

These durable, waterproof neoprene covers keep your seats free from dirt and grime, and offer full airbag compatibility.



### REAR SEAT COVERS

Guard against dirt, spills, damage and the effects of wear with this lightweight, waterproof cover.



### CARGO ILLUMINATION

Additional LED lighting that allows for a clearer view of the load compartment.



### CARGO COVER

Keep valuable items hidden from view.



### SCUFF PLATES

Guard door sills from scratches and scuffing with protective plates styled to enhance the look of your CX-9.



### WELCOME ILLUMINATION

Welcome lighting radiates soft blue illumination from both foot wells.

FEATURED HERE

- Front mud guards
- Rear mud guards
- Roof racks
- Slimline weathershields
- Tow bar\*



\*Features maximum 2,000kg braked towing capacity and 100kg tow ball download limit. Subject to State or Territory regulations. Chrome tow ball sold separately.

Azami in Machine Grey Metallic.



BIKE RACK (WHEEL OFF)

Makes it easier to take your bike along for the ride.



BIKE RACK (WHEEL ON)

Transport your bike without the inconvenience of removing a wheel.



KAYAK HOLDER

A convenient way to carry a canoe, kayak or similar sized watercraft.



#### BONNET PROTECTOR

Guards the bonnet against damage caused by road debris. (Smoke Bonnet Protector also available)

#### HEADLIGHT PROTECTORS

Shield headlamps from costly damage.



#### FRONT PARKING SENSORS

Take the guesswork out of parking with audio alerts advising the distance between your CX-9 and objects to the front. (Sport and Touring models only)



#### FRONT MUDGUARDS

Stop mud and road grime collecting on the front bodywork of your car.



#### REAR BUMPER STEP PLATE

Protect tailgate paintwork from damage while enhancing its appearance.



#### COLLAPSIBLE SUN SCREEN

Keep your vehicle cool and protect the interior from the sun's harmful rays.



#### ELECTRONIC BRAKE CONTROLLER

Supplies power to a towed trailer's electric brakes when the CX-9's brakes are applied.

#### ALSO AVAILABLE

- |                                   |                               |
|-----------------------------------|-------------------------------|
| Audio retractable Lightning cable | Mazda retractable audio cable |
| Audio retractable Micro USB cable | Rear floor mats               |
| Black wheel lock set              | Tow ball                      |
| Chrome wheel lock set             | Tow ball cover                |

SEE THE FULL RANGE OF MAZDA GENUINE ACCESSORIES AT [MAZDA.COM.AU](http://MAZDA.COM.AU)

All care is taken to ensure the accuracy of this brochure and availability of vehicles and features at the time of publication, however, to the extent permitted by law, Mazda Australia Pty Ltd will not be liable for any loss suffered or incurred by a purchaser or prospective purchaser if the content is inaccurate or not up to date, or if it withdraws any vehicles or features referred to in the brochure from the market. Sports and other equipment shown in the brochure are for illustration purposes only and do not come standard with the vehicle, or as Mazda Genuine Accessories. Specifications, features and availability may vary from State to State and may change without notice. Please refer to [mazda.com.au](http://mazda.com.au) or consult your Mazda Dealer prior to placing an order to ascertain current information on availability, specifications, features and prices. Mazda Australia Pty Ltd ABN 78 004 690 804. 211A Wellington Road, Mulgrave VIC 3170. All Mazda Genuine Accessories fitted at the point of sale of a new Mazda passenger vehicle are covered under the Mazda 3-year/unlimited kilometre warranty. Mazda Genuine Accessories fitted after the sale of a new Mazda vehicle are covered by the Mazda 2-year or 40,000 kilometre warranty (whichever should occur first). iPhone® is a trademark of Apple Inc., registered in the U.S. and other countries. Published October 2017. MAZ13430 126.034